

NC型 兩節式經濟型



NC-※※-00A

附屬品：強力銷、固定銷各1支、扣環2個，
須強力銷2支時請以下式訂購

NCA※※-00A

追加工不可

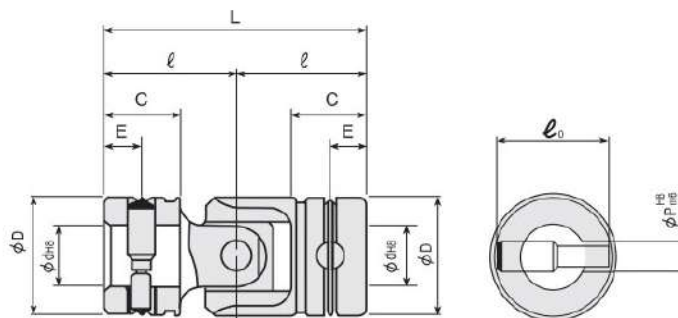

NC-※※-01A

附屬品：
強力銷1支、扣環2個
追加工不可

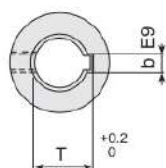
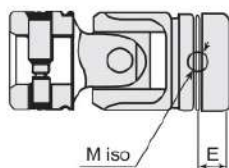

NC-※※-02A

附屬品：
扣環2個
追加工不可

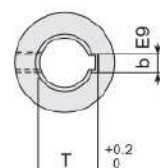
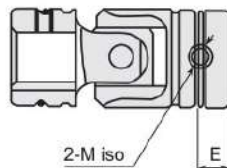

NC-※※-05A

(手動專用無熱處理)

追加工可能

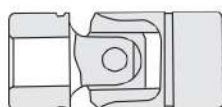

NC-※※-※※C

(附防塵套)

已充填油脂
訂購時請預先說明

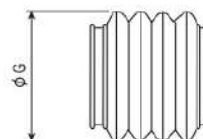

公稱番號	尺寸	d	D	C	E	l	L	P	l ₀	b	T	M	G
NC-06-※※※		6	12	9	4.5	15.5	31	3	10	—	—	—	
NC-08-※※※		8	15	10	5	18	36	3.5	12.5	—	—	—	25
NC-10-※※※		10	20	12	6	21	42	4.5	16.5	—	—	—	32
NC-12-※※※		12	23	15	7.5	26	52	5	20.5	4	13.5	5	35
NC-14-※※※		14	26	17	8.5	29.5	59	5.8	23	5	16	6	40
NC-16-※※※		16	30	22	11	37	74	6.5	26.5	5	18	6	46
NC-18-※※※		18	33	23.5	11.75	40.5	81	7	28.5	5	20	6	52
NC-20-※※※		20	36	25	12.5	43.5	87	8	31.5	5	22	6	58
NC-25-※※※		25	44	30	15	52.5	105	10	38.5	7	28	8	68
NC-30-※※※		30	51	35	17.5	61	122	11.5	44	7	33	8	82

註：未標示的尺寸與NC-※※-00A相同

NC型無貯油設計，可使用防塵套（內充油脂），又初期運轉的給油及定期給油須做好，給油時在接頭部外圍塗布油脂，且油脂以#90潤滑油較好。